









Thanks for choosing Thunder

Your Thunder Kit is a compact, lightweight solar solution designed for ease of use. It includes solar panels, a microinverter, AC/DC extension cables and a fused spur.

Thunder is built to support, not replace, your energy use. It helps offset some of your daytime consumption, cutting your bills while giving something back to the planet.

That said, it's still a system powered by electricity. Please handle it with care at every stage, from installation to everyday use. If you're not sure about something, play it safe. Contact a qualified electrician or reach out to us anytime at support@thunderenergy.co.uk.

TABLE OF CONTENTS

 Safety Instructions 1-2	 AC Extension Cable Connection 10
 What's in the Box 3-4	 Connecting Panel Cables to the Microinverter 11-12
 Before We Start 5	 System Start-Up / Monitoring Generation 13
 Hanging Your Panels 6-7	 Connection the Microinverter to Your Home WiFi 14
 System Layout 8-9	

SAFETY INSTRUCTIONS

Safety Instructions Overview

Please ensure that you read all safety instructions thoroughly before beginning installation or operation of this solar kit. Improper handling may result in personal injury, property damage, or invalidation of your warranty.

Pre-Installation Checks & Handling

Before starting, verify that all kit components are present and undamaged. Do not proceed if any parts are missing, bent, cracked, or otherwise compromised. Contact Thunder Support immediately if you encounter any issues.

Installation Requirements & Electrical Safety

Installation must strictly comply with all applicable UK wiring regulations, including G98 and BS 7671 standards.

All electrical modifications to fixed wiring within a dwelling must adhere to Building Regulations Part P. This includes work such as adding a PV circuit, modifying the consumer unit, or installing battery storage, all of which must be completed by an installer registered with a Competent Person Scheme (CPS), such as NICEIC or NAPIT.

Although DIY installation is permitted, if the work is not performed by a CPS-registered installer, it must be formally inspected and signed off by either a registered third-party certifier or your local Building Control Authority, in line with legal requirements.

All electrical work associated with this kit must be carried out by an installer registered with a Competent Person Scheme (CPS) such as NICEIC or NAPIT. To find a registered installer in your area, visit www.electricalcompetentperson.co.uk.

RCBO Installation

A bi-directional RCBO, compatible with the existing consumer unit, is required for the dedicated radial circuit. The RCBO is not included in this kit as consumer units vary between properties. The installer must ensure coordination with existing circuit protection. The system circuit runs from a bi-directional RCBO in the consumer unit, through the dedicated radial cable, to the fused spur which serves as the local AC isolator for the system.

Live Voltage Precautions

This system operates at live voltages and poses a risk of electric shock. Always isolate AC power at the fused spur before disconnecting DC cables. Never disconnect solar cables under load, and cover panels with an opaque cloth before any disconnection to prevent accidental exposure to live terminals.

Do not expose the AC and DC connectors to rain or moisture until connected.

SAFETY INSTRUCTIONS continued

Connection & Disconnection Order

Connection: Connect the AC side first, then the DC side.

Disconnection: Always switch off the AC before unplugging DC cables.

Weather, Mounting, and Physical Safety

Installation must not be attempted in adverse weather conditions such as rain, snow, or strong winds.

Always involve at least two individuals; one to secure the panel and one to perform mounting. Each panel must be fastened with a minimum of five straps.

Take particular care to prevent objects from falling and causing injury, especially when mounting above public spaces or on balconies. Do not install the kit near corrosive, flammable, or explosive materials.

The microinverter may become hot during and shortly after operation. Do not touch it until it has cooled completely.

Maintenance & Modifications

This kit is designed for low maintenance but requires an annual visual inspection.

Unauthorized modifications or use of non-approved components are strictly prohibited.

Child Safety

The system must be always kept out of reach of children. Children should never be permitted to play near or with any part of the unit.

Liability Disclaimer

Thunder disclaims liability for any damage or injury resulting from failure to follow these instructions, improper installation or use, unauthorized modifications, the use of third-party parts, or events beyond our control, such as natural disasters.

WHAT'S IN THE BOX

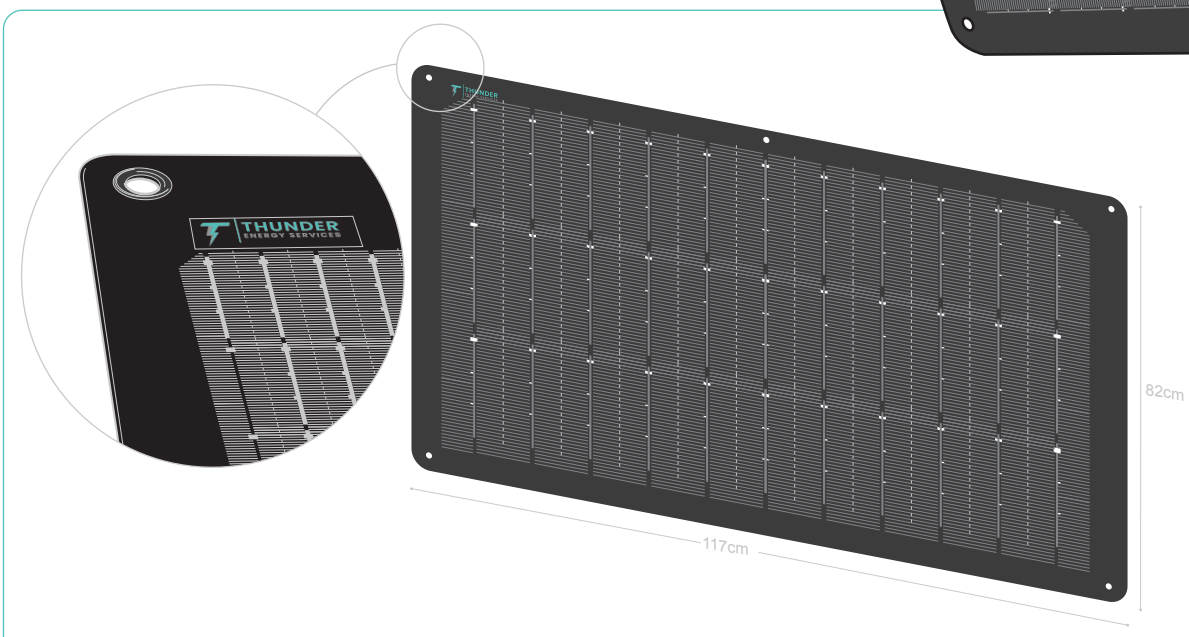
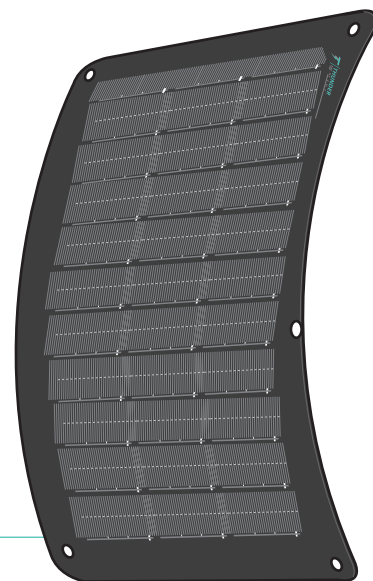
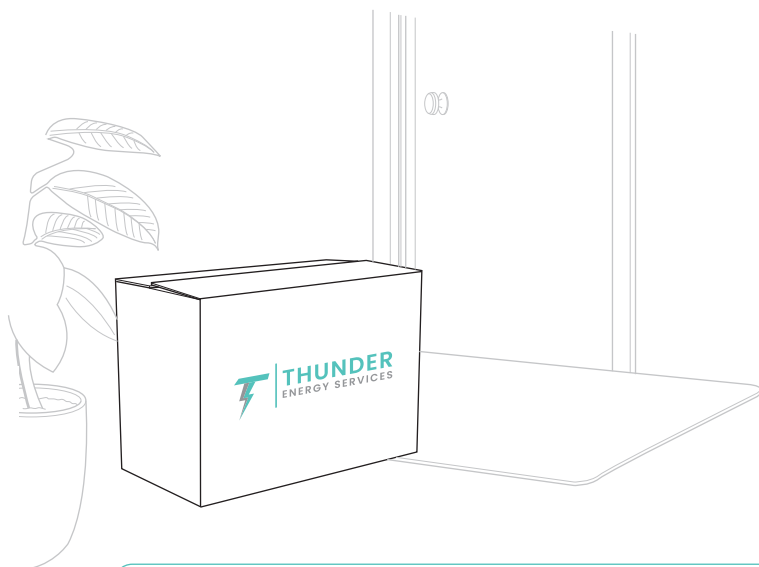

Solar Panels

- Sets of 2 or 4 identical Panels
- Mount horizontally or vertically depending on choice

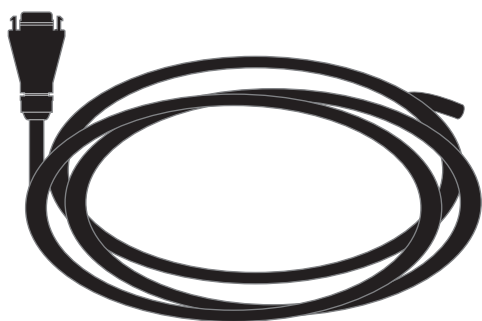

AC Connection Cable

- 5m or 10 m length depending on your set



Y-Branch DC Connector

- Included with 710W kit only

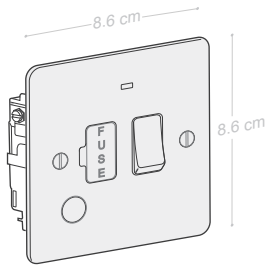

Double Pole Insulator Fused Spur
• Licensed Installation

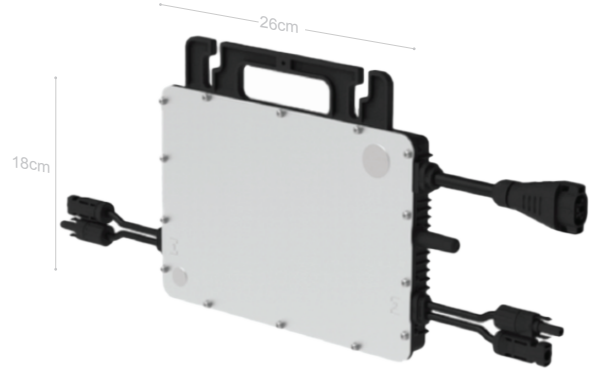

Microinverter
• HMS-800W-2T

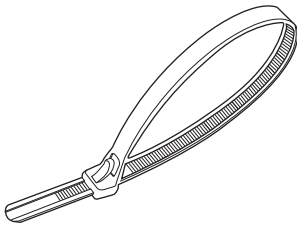

Reusable Cable ties

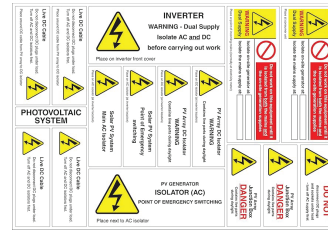

Solar Warning Labels

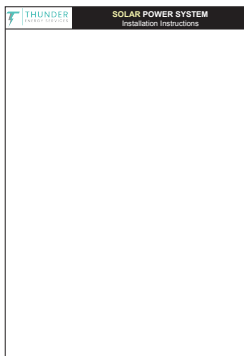

Installation Guide

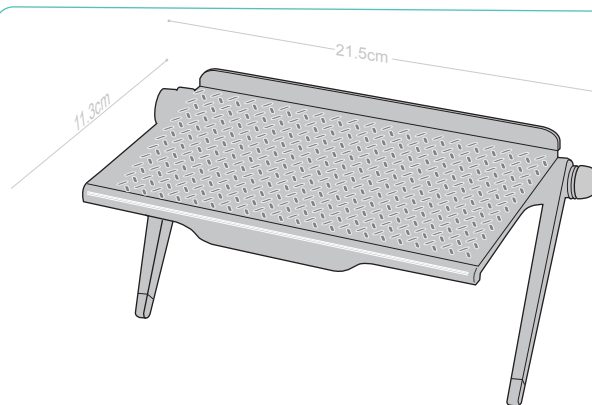

Microinverter Stand

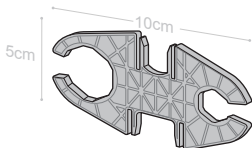

Disconnect Tool A

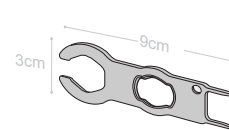

Disconnect Tool B

BEFORE WE GET STARTED

Do not install panels under direct sunlight.

If exposed to strong sunlight during installation, temporarily cover them with an opaque sheet to avoid electricity generation.

Choose a location that receives the most consistent sunlight throughout the day. This will help maximize the efficiency and output of your solar kit.

Important:

This system must be connected via a dedicated radial circuit in accordance with UK wiring regulations. A dedicated radial circuit runs directly from the consumer unit to an outlet without being shared with other appliances. Common examples include garden sockets, garage outlets, or disused heater and cooker spurs. Any of these can be repurposed for your solar system, provided the circuit is verified by a qualified electrician. Alternatively, a new radial circuit can be run from the consumer unit to a suitable location near the panels. The fused spur must be installed within reach of the AC extension cable supplied with your kit (5m or 10m depending on your set).

Check the area for secure places to attach the solar panels. Panels can be secured to the mounting surface using the ties provided, threaded through the metal eyelets. Alternatively, panels can be fixed using wall plugs and screws through the eyelets. Do not overtighten. Place a washer or ring fitting over each screw head to hold the panel securely against the surface.

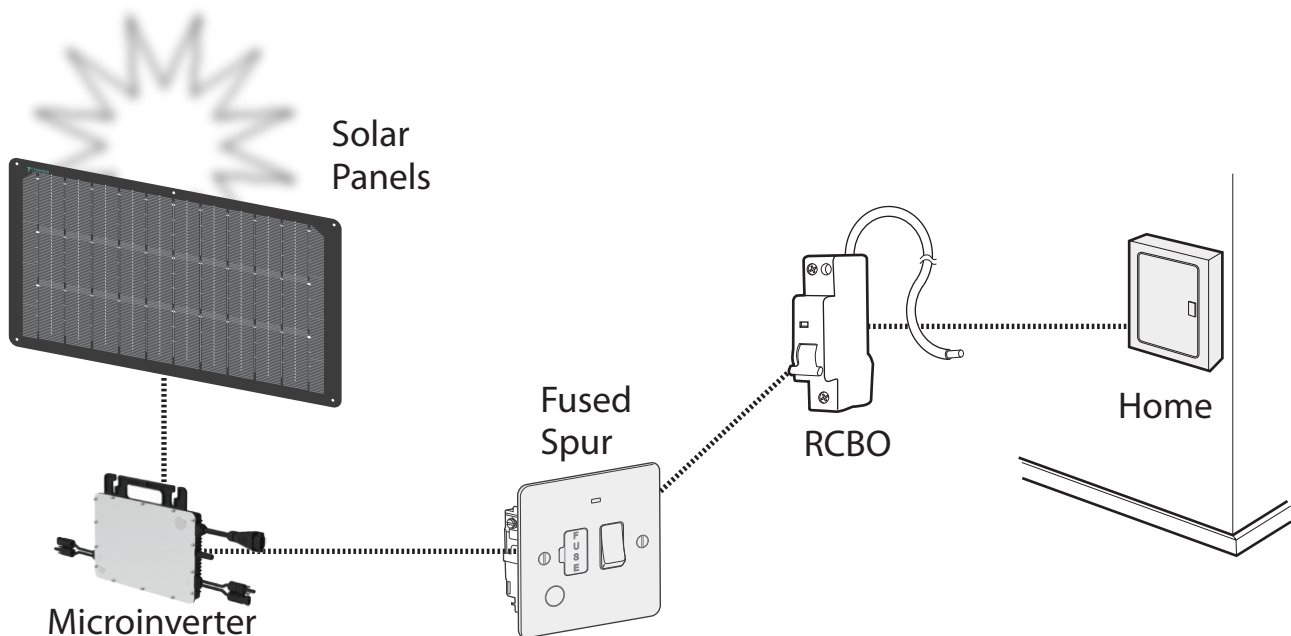

INSTALLATION - HANGING PANELS FROM BALCONY RAILING

STEP ①

For balcony set-ups, position the Panels horizontally **-or-** vertically.
Secure the panels by passing the reusable cable ties through the metal eyelets and attach them to a railing or any solid anchor point such as a screw hook.
Make sure all straps are tightly fastened to keep the panels stable in all weather.

If not installing on a balcony, see the next page for other hanging scenarios.

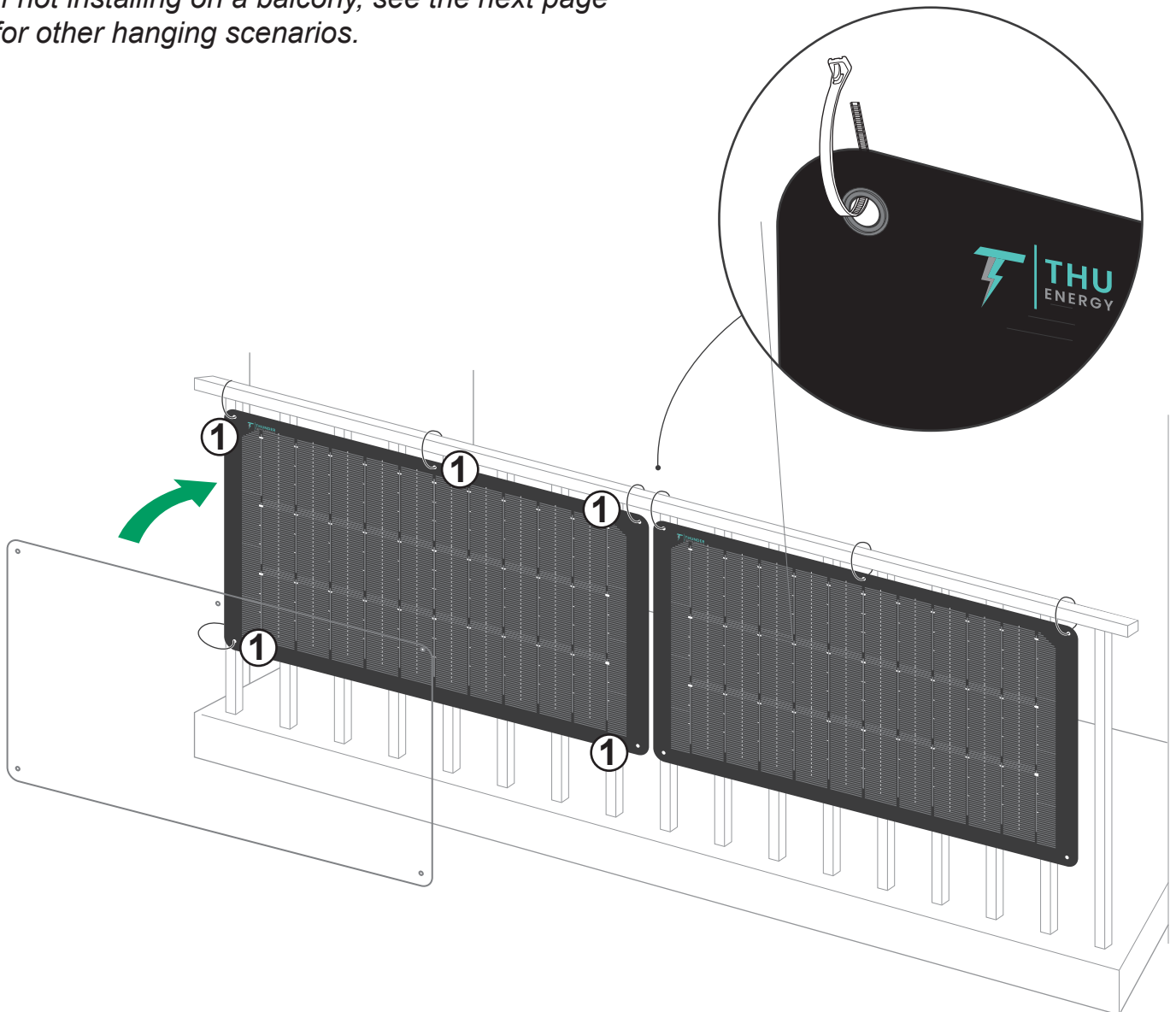

INSTALLATION - HANGING PANELS FROM FENCE

Panels can be hung on any sunny, stable surface such as a fence, garage wall or patio. Secure using cable ties through the eyelets or fix with screws and wall plugs. When screw-fixing, use a washer against the panel and a 20mm spacer to clear the rear junction box. Fixings not included.

STEP ①

For garden and fence set-ups, position the Panels horizontally -or- vertically.

It is important to mount to a stable surface that receives as much sun as possible.

Insert a screw hook into the fence and use it as an anchor to secure all 5 holes with cable ties, or simply wrap the cable ties around the fence.

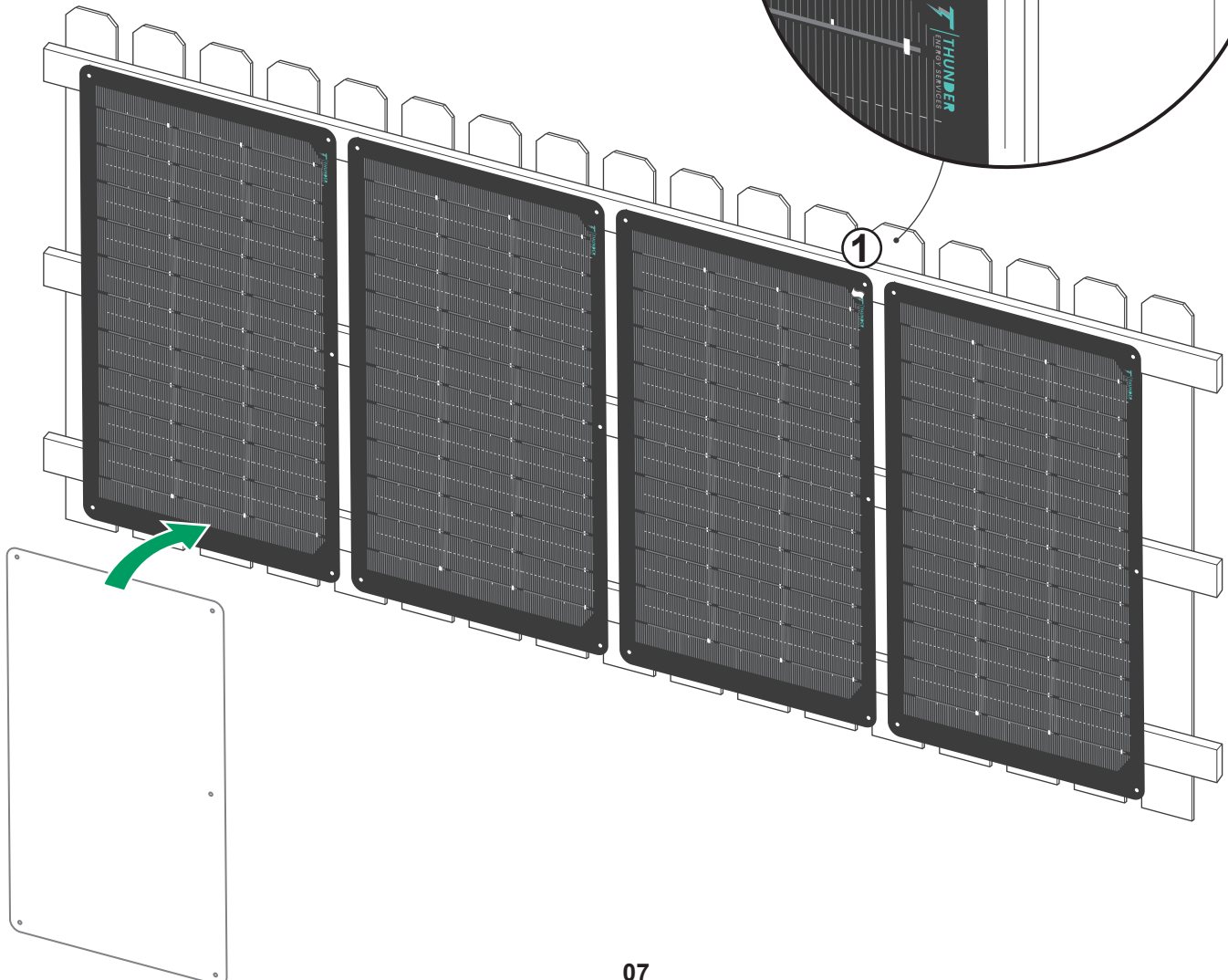
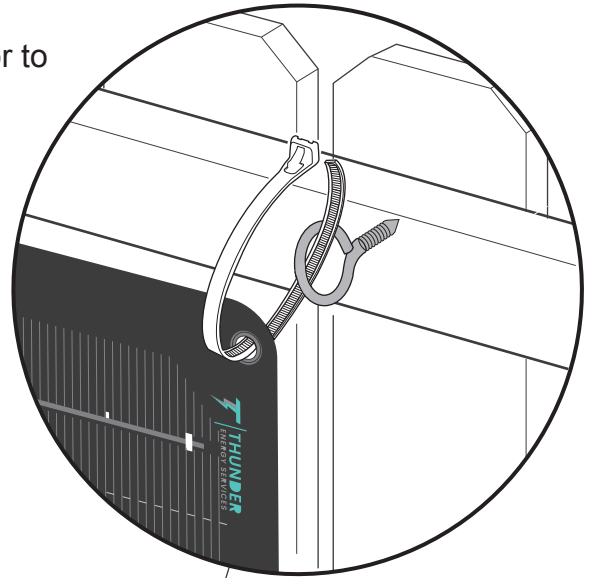

SYSTEM LAYOUT - PANELS ON BALCONY RAILING

STEP ②

Working from the inside of your Balcony, position the Microinverter in the center of your Solar Panel set-up. As an option, you can set the Microinverter on the Microinverter Stand, with the black surface facing up.

DO NOT connect any cables to the Solar Panel yet. Only connect the Solar Panel cables after the AC Extension Cable has been connected to the house power (via the Fused Spur) and to the Microinverter's AC input.

CAUTION:

Never connect or disconnect cables while the system is powered on.

Always match positive and negative MC4 connectors to the correct Microinverter inputs.

You can use the provided Microinverter Stand to support the Microinverter at an angle, rather than placing it directly on the ground.

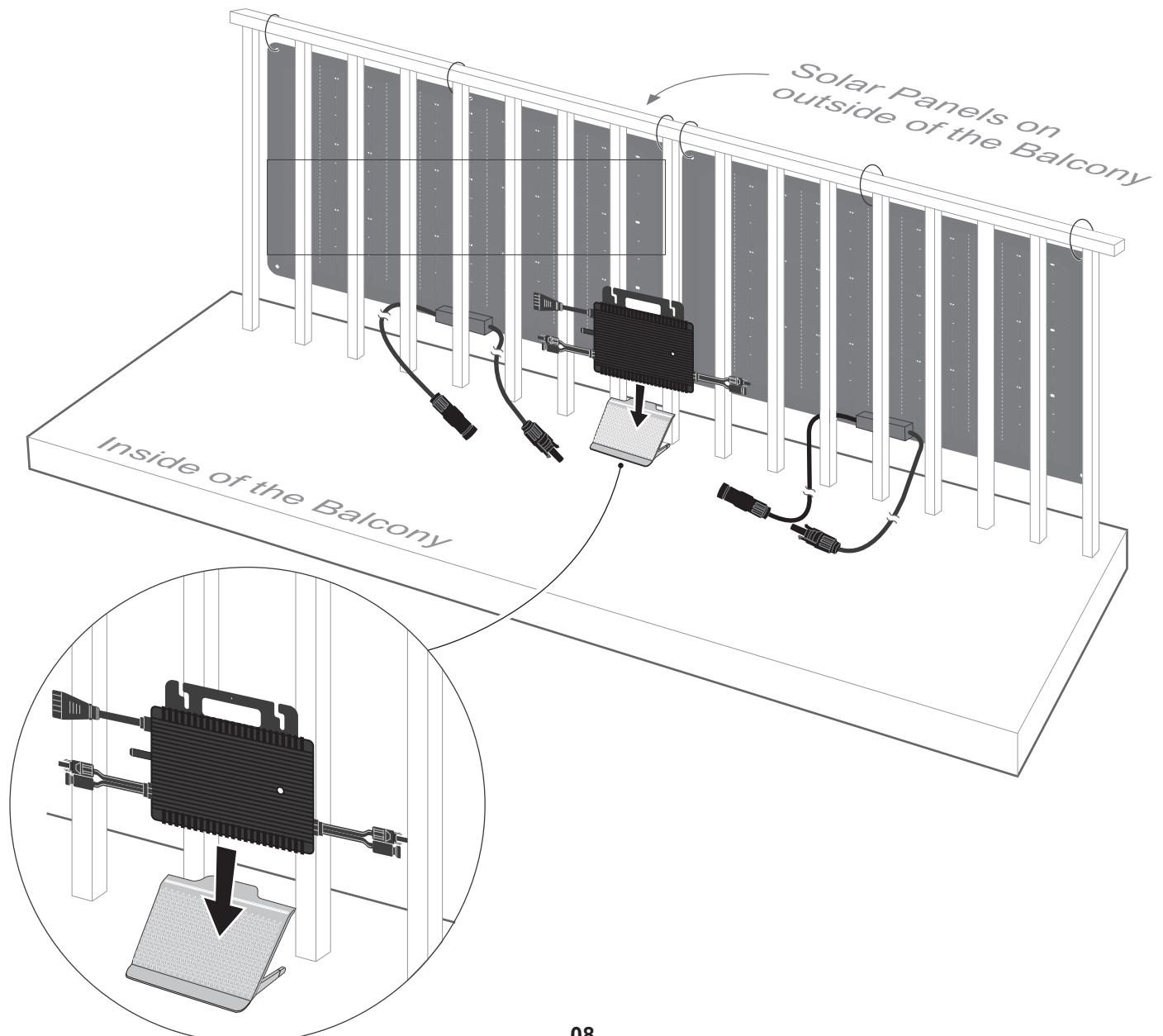

SYSTEM LAYOUT - PANELS ON FENCE

STEP ②

Working from the inside of your garden and fence set-ups, position the Microinverter in the center of your Solar Panel set-up. As an option, you can set the Microinverter on the Microinverter Stand.

DO NOT connect any cables to the Solar Panel yet. Only connect the Solar Panel cables after the AC Extension Cable has been connected to the house power (via the Fused Spur) and to the Microinverter's AC input.

CAUTION:

Never connect or disconnect cables while the system is powered on.

Always match positive and negative MC4 connectors to the correct Microinverter inputs.

You can use the provided Microinverter Stand to support the Microinverter at an angle, rather than placing it directly on the ground.

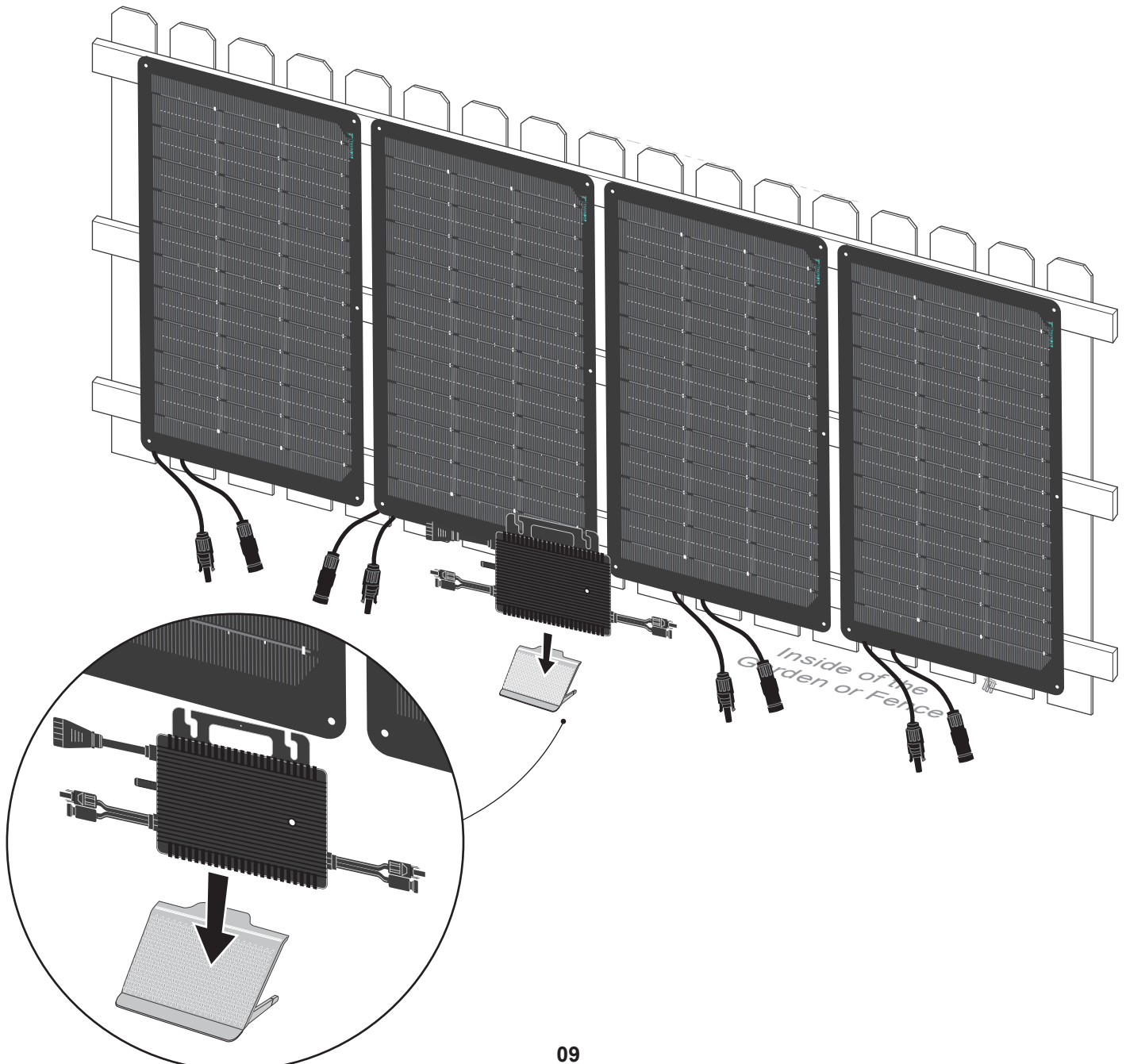

AC EXTENSION CABLE CONNECTION

STEP ③

The installer should continue by connecting the live, neutral, and earth wires to the output terminals of the provided double-pole isolator fused spur.

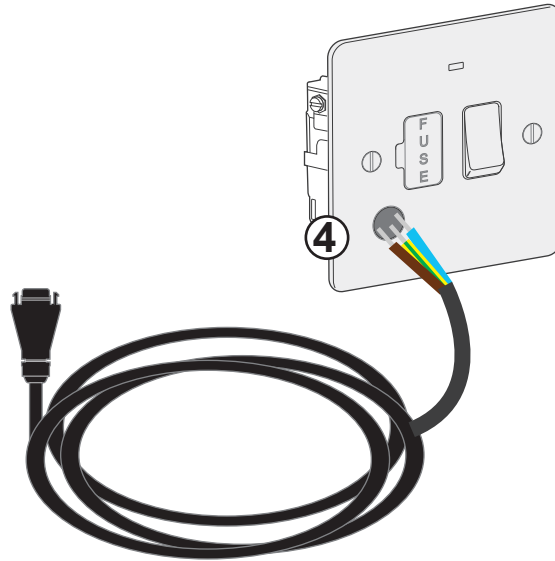

Safety First! Always switch off power at the main consumer unit before starting any work on the AC system. Use a voltage tester to ensure all cables are de-energized before handling. Complete the connection on the house side only after confirming the circuit is safe and isolated,.

STEP ④

Install the fused spur at the planned radial socket location, ensuring all connections are secure.

Set the fused spur to the off position and attach the “Solar PV System Main AC Isolator” label.

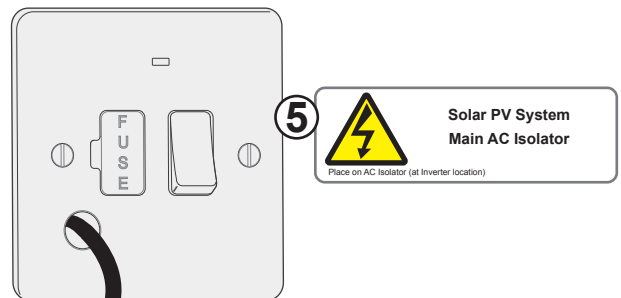

STEP ⑤

Connect the AC Extension Cable’s microinverter end directly to the microinverter’s AC input using the quick-fit connector.

For maintenance or relocation, use the provided disconnectors to safely separate both the AC and DC connections. Always ensure the system is fully powered down before disconnecting.

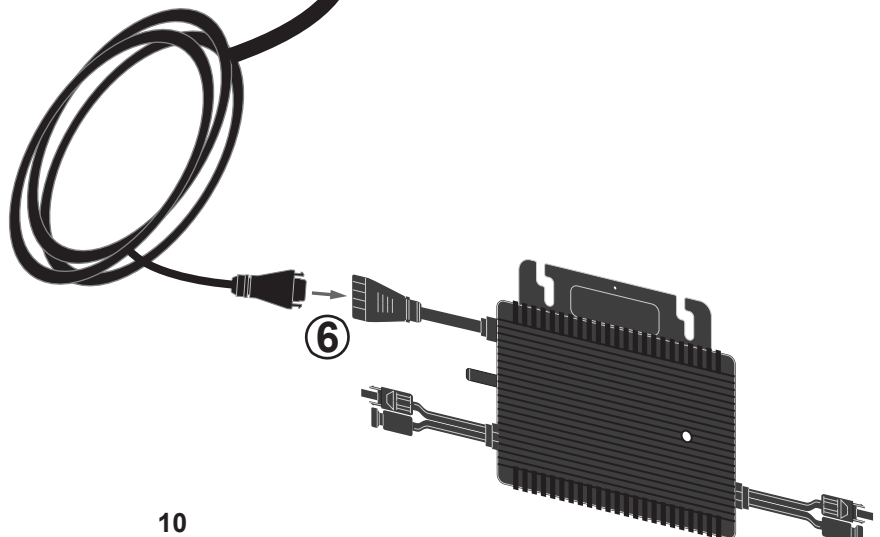

CONNECTING PANEL CABLES TO THE MICROINVERTER 2- PANEL CONFIGURATION

STEP ⑥

You will connect the positive and negative MC4 cables from each Solar Panel directly to the corresponding inputs on either side of the centrally located microinverter.

Do not connect panel cables to each other.

Always match positive and negative MC4 connectors to the correct Microinverter inputs.

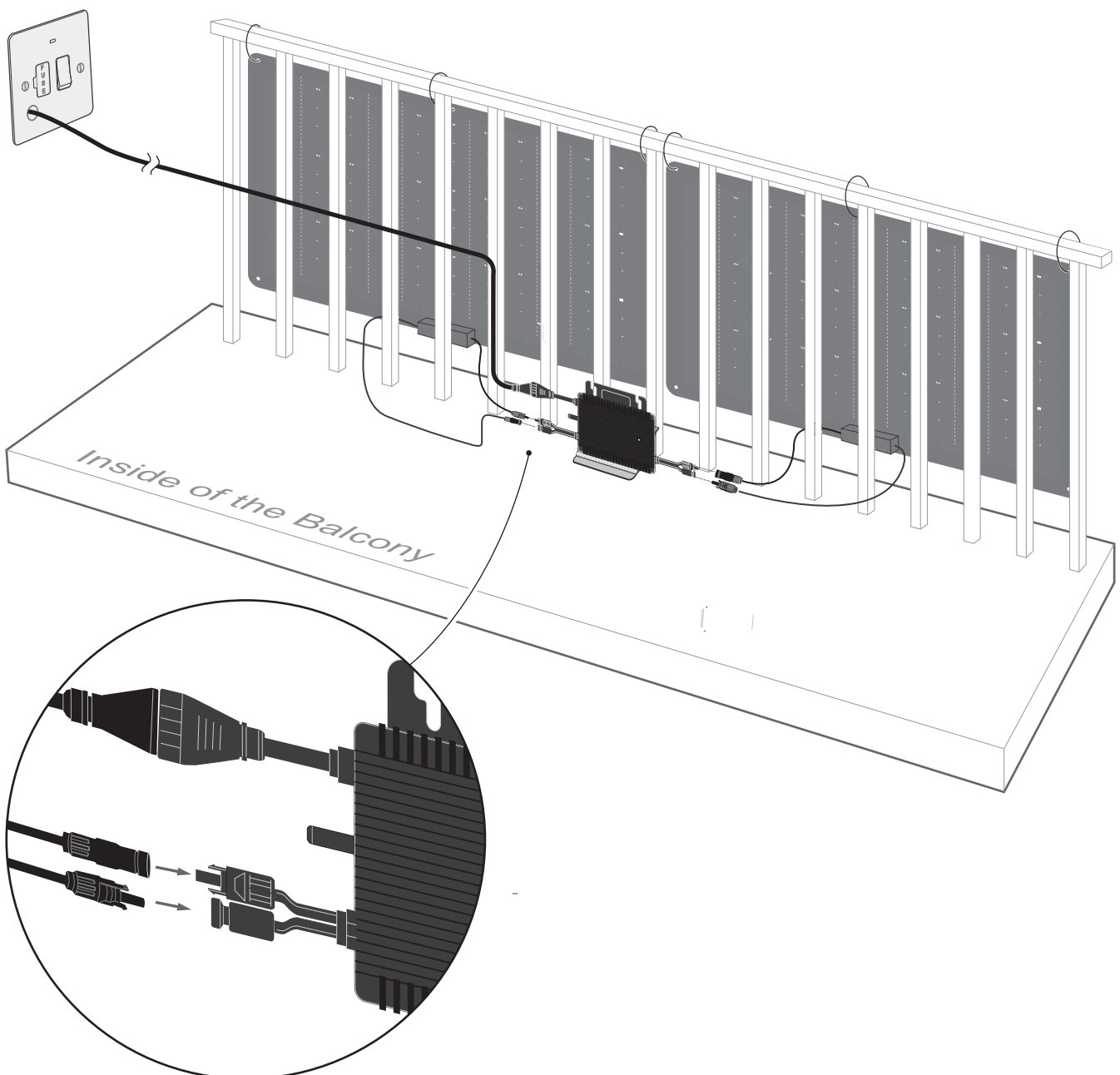

CONNECTING PANEL CABLES TO THE MICROINVERTER 4 - PANEL CONFIGURATION

STEP ⑥ Use the provided Y-branch cables to combine each pair of panels on either side. Then connect the Y-branch outputs to the two input sides of the microinverter, ensuring correct polarity.

Insert each MC4 connector firmly until you hear a distinct "click," confirming that the connection is secure.

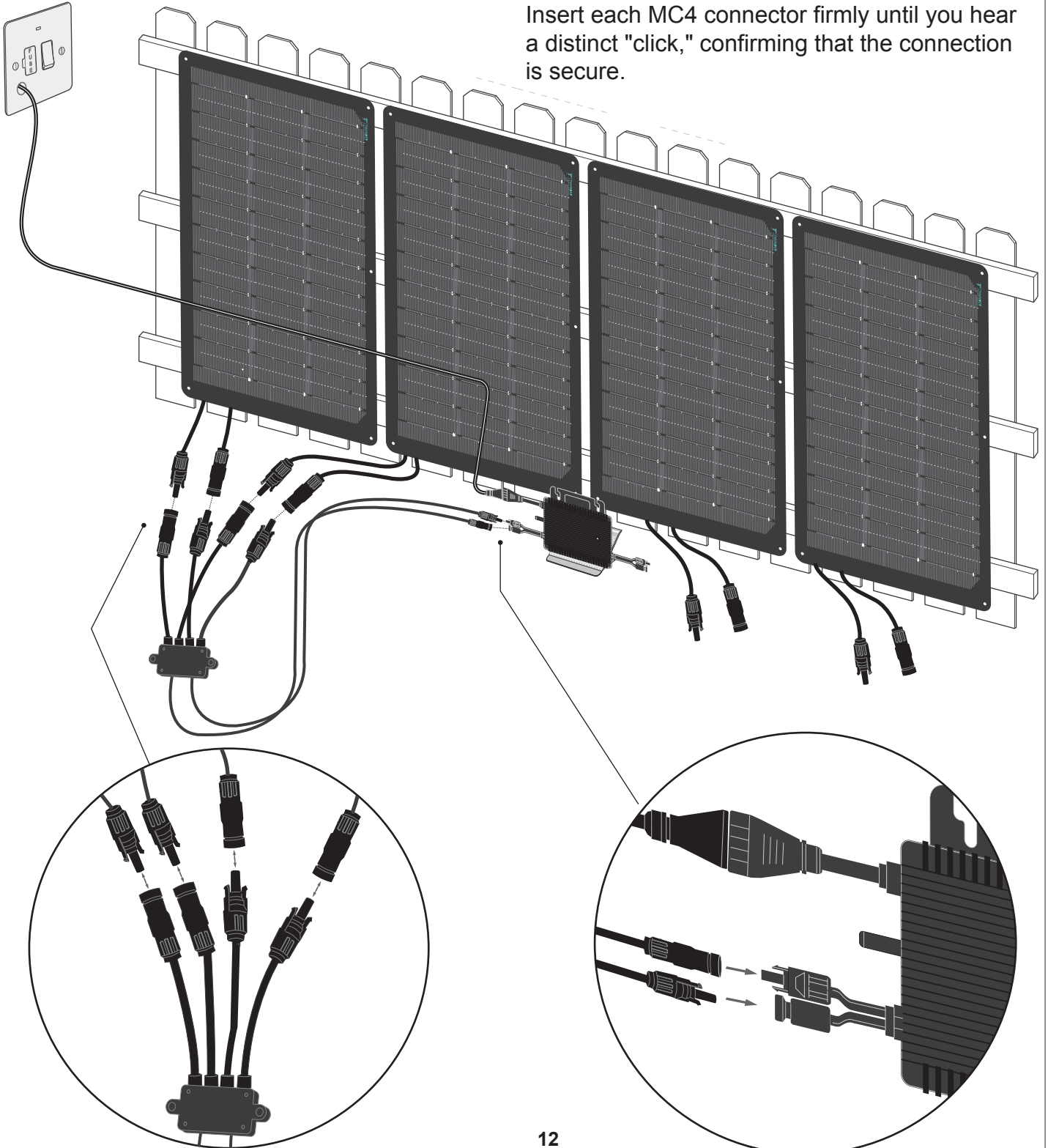

SYSTEM START-UP



STEP 7

After all connections are completed, switch the fused spur to the ON position and wait two minutes for the system to begin producing power. The microinverter will automatically synchronize with the grid's electrical characteristics.

Once synchronized, the microinverter will begin feeding the electricity generated by your Solar panels into the grid. Welcome to clean energy! Your system is now generating renewable power and contributing to a more sustainable future.

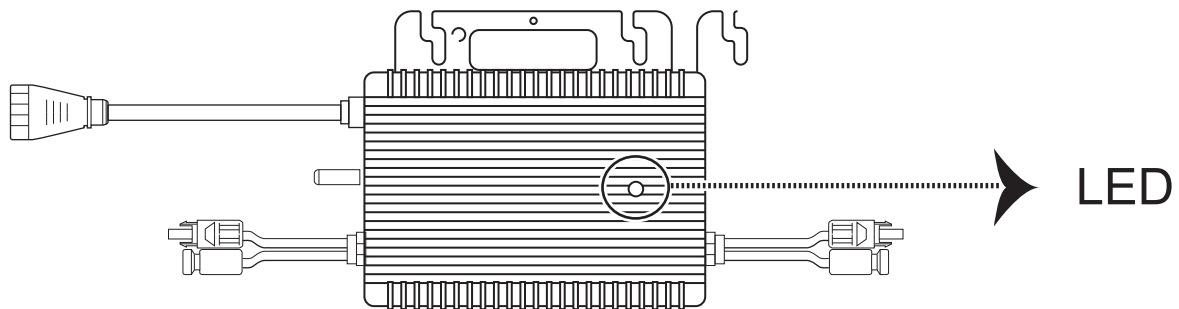
Note: Check the LED on the dark side of the microinverter to ensure it is operating normally.

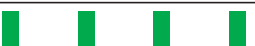

LED		INDICATES
FastGreen Blink (5 times, 0.3s gap)		Start-up Success
Green Flashing (1s gap)		Producing Power
Red Flashing (1s gap)		AC Grid Fault

MONITORING GENERATION

STEP 8

Download the S-Miles Enduser app from your device's app store.



Using this app, you can connect your microinverter directly to your home WiFi. This allows the microinverter to send production data to the cloud, enabling you to monitor generation through the app.

When you open the app, both your login account and password are typically set as the part of your email address before the "@" symbol (you can change this later in the app).

CONNECTING THE MICROINVERTER TO YOUR HOME WIFI

STEP ⑨

Note: To connect your microinverter to your home WiFi using the app, the device must be powered on. If the kit is off, the microinverter will not operate and cannot be accessed for setup. Carry out the WiFi connection process while the system is running.

In the S-Miles Enduser app, tap the menu or profile icon and open “Network Configuration.” Select the “Via WiFi” option to access the WiFi settings. Connect to the device’s network (for example, “DTUP-XXXXXX”).

Note: Your phone may automatically reconnect to your home WiFi during this process. To avoid interruptions, it’s recommended to temporarily disable the automatic connection to your home WiFi.

Next, enter your home WiFi password and tap “Connect” or “Send to Device.” Wait until you see a success message confirming the connection is complete. The system is now sending production data to the cloud via your home WiFi, allowing you to monitor it in real time. Enjoy monitoring your solar production!

Reminder: Attach a dual supply warning label above the circuit breaker in the consumer unit where the dedicated radial circuit is connected.